

LESSO

WINDOWS&DOORS SYSTEM SOLUTION

LESSO

CHINA LESSO GROUP HOLDINGS LIMITED

(China Lesso, Stock Code: 2128.HK)
www.lesso.com

FOSHAN LIANSU BUILDING MATERIAL TRADING COMPANY

Add: Liansu Industrial Estate, Longjiang Town, Shunde District, Foshan City,
Guangdong Province, China
Tel: +86-757-2981 3877 Fax: +86-757-2337 8980
E-mail: oversea@lesso.com

This catalog has prepared as support guide.Under no circumstance shall LESSO
assume any liability or responsibility with the information in this catalog.Every effort
has been made by LESSO to provide accurate and up to date information.

All Rights Reserved 2020.10
Printed in China(HC)



CONTENTS

01

About China Lesso 01

02

Production Advantage 03

Production Base 03

Production Line 04

Management Regulation 05

03

Superiority 07

04

Product Introduction 09

Patio Door System

PD02 Series

PD02 Single Hung Sliding Door 11

PD02 Double Hung Sliding Door 12

SG Window System

SG005 Series

SG005 Fixed Window 14

SG005 Casement Window 14

SG005 Single Hung Sliding Window 15

SG005 Double Hung Sliding Window 16

SG010 Series

SG010 Fixed Window 18

SG010 Casement Window 18

SG010 Single Hung Sliding Window 19

SG010 Double Hung Sliding Window 20



LESSO DOORS AND WINDOWS



CHINA LESSO

China Lesso Group Holdings Limited (Stock Name: China Lesso, Stock Code: 02128.HK) is a large industrial group of home furnishings and building materials in China. China Lesso offers products, services and channels involving piping, building materials and home furnishings, environmental protection, and modern agriculture. Its product portfolio spans piping, plumbing and sanitary ware, integral kitchen materials, integral doors and windows, decorative plates, water purifiers, water-proofing materials and sealants, fire-fighting equipment, valves, cables, lighting, hygiene materials, items for environmental protection, agricultural facilities, and oceanic aquaculture cages. Its sales revenue has reached RMB 26.345 billion in 2019.

With the rapid development of internationalization and globalization, China Lesso boasts more than 80 holding subsidiaries and more than 23 production bases distributed in 18 provinces across China, and in Canada and Indonesia. China Lesso remains committed to improving its strategic layout, broadening its sales network and expanding the market. This is how it provides products and services for customers in a timely and efficient way.

China Lesso has established its R&D center with more than 1,000 scientific researchers. The Group now boasts ten national high-tech enterprises, one national accredited enterprise technology center, two post-doctoral workstations, five China national accredited laboratories authorized by CNAS, one key enterprise laboratory of plastics molding and processing technology in Guangdong Province, and one union of Technical Innovation of Plastic Pipe Industry in Guangdong Province.

China Lesso owns about 1817 patents (some of them are pending). Some of Lesso's scientific achievements are included in National Torch Plan Projects, National Key New Product, Scientific Achievements Promotion Projects in National Construction Industry and Government Green Procurement List. The Group has been awarded many honorary titles and prizes, such as Champion Manufacturer, China Construction Independent Science Innovation Superior Enterprise, Intellectual Property Right Preponderant Enterprise, Industrialization Demonstration Base, Guangdong Provincial Government Quality Prize, and the First Prize of Scientific Technological Progress in Guangdong Province, and the First Prize of Scientific Technological Progress of China Light Industry Association.

As a domestic manufacturer of extensive home furnishings and building materials, China Lesso offers over 10,000 varieties of products with all specifications. Its products are being widely used in many areas, including home decoration, civil construction, municipal water supply, drainage, power supply and telecommunications, gas supply, fire-fighting, environmental protection, agriculture and oceanic aquaculture.

True to its mission of "Creating a Relaxing Life", China Lesso will present a brand new image and offer more high cost-effective products and services to customers so that they can enjoy a comfortable and quality life.

80 holding subsidiaries

23 production bases distributed

1817 patents

10,000 varieties of products



PRODUCTION ADVANTAGE

PRODUCTION BASE

Until now, China Lesso group has two subsidiaries that manufacture window and doors, which are located in Toronto, Canada, and Heshan, Guangdong respectively.

01 Production base in Toronto, Canada

The branch of Lesso in Canada



02 Production base in Heshan, Guangdong

It provides technical guidance, production, storage and other services for domestic and overseas customers.



PRODUCTION LINE

China Lesso introduces a full set of international brand equipment, which includes Germany Battenfield extrusion lines, advanced assembling machines such as Germany Ame-pressta, KINGSKY Machinery and DECA, so as to manufacture top level products of consistent quality.



MANAGEMENT REGULATION

The success in product quality originates from strict management regulation and quality control system.

Lesso possesses excellent product management team. There are 3 methods for product testing, such as self-inspection, mutual-inspection, sampling inspection from professional inspector during quality control operation. In terms of ordering management, we also introduce DECA ordering system- "Star of Windows and Doors", effectively improving the coordination between ordering and production, and providing good services for clients timely.



International Authority Certification

By virtue of technology improvement and strict quality control, our products pass the inspection by American Architectural Manufacturers Association and get AAMA certifications.



SUPERIORITY

01

Thermal Insulation and Energy Efficient

PVC window and door profiles have a low thermal conduction, which can reduce the loss of energy. They are designed with multi-chambers which also reduce the transmission of heat.

02

Fire Resistance

PVC materials used in windows and doors are difficult to ignite and do not support or enhance accidental fires unlike their timber Counterparts.

03

Sound Insulation

The multi-chambers, welded corners and tight seals offer excellent sound insulation.

07

Maintenance Free

The closed smooth surface of PVC profiles ensures ease of clean by using gentle household detergent dissolved in water. They are also available with a foil coating in different colors, so you do not need to paint it.

08

Weather Resistance

When PVC windows and doors are exposed in scorching sun, storms, dryness, high humidity or other extreme weather change, They do not rot, corrode nor warp. Even after many years, the windows and doors are still attractive, perfectly tight and working well.

04

Electricity Insulation

PVC window and door profiles have a high electricity insulation.

05

Water Tightness

PVC window and door profiles have low water absorption rate less than 0.1%.Moreover the uniquely designed weep hole and weatherstrip in the meeting rail provide water resistance proof.

06

Strength and Security

All main PVC profiles are reinforced with steel, providing a high level of security.

09

Environmental Friendly

PVC windows and doors can be fully recycled.

10

Corrosion Resistance

PVC windows and doors profile is free from the attack of acids, alkalis, waste gases, and salts.



Thermal Insulation and Energy Efficient



Fire Resistance



Electricity Insulation



Sound Insulation



Water Tightness



Strength and Security



Maintenance Free



Weather Resistance



Environmental Friendly



Corrosion Resistance

PRODUCT INTRODUCTION

PATIO DOOR SYSTEM



PD02 Series

PD02 Single Hung Sliding door

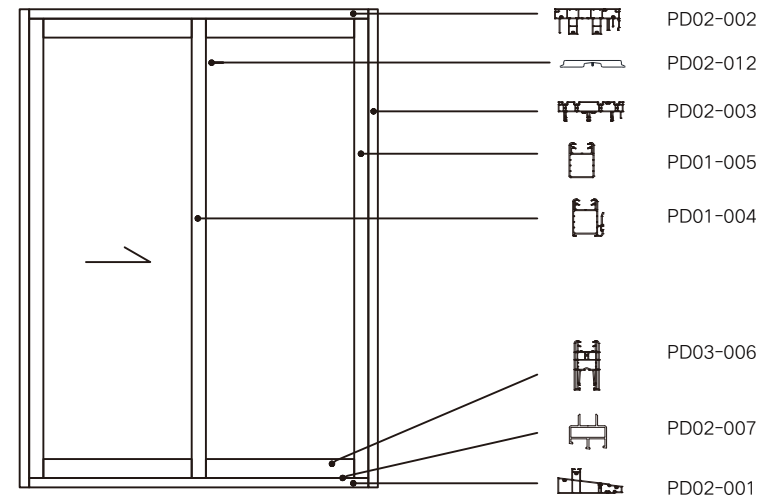

PD02 Double Hung Sliding door

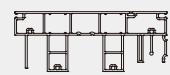
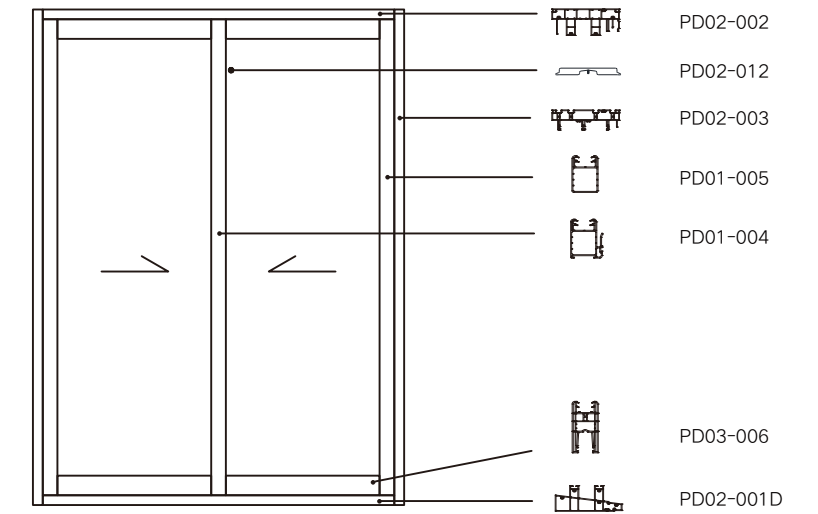

Description	ALL VINYL HEADER PD02-002
Package	4 Pieces/Bag
Weight	2KG/M

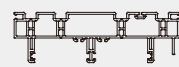

Description	ALL VINYL JAMB PD02-003
Package	4 Pieces/Bag
Weight	1.640KG/M

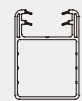

Description	LOCKER RAIL PD01-005
Package	12 Pieces/Bag
Weight	0.580KG/M

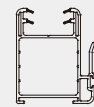

Description	INTERLOCK PD01-004
Package	8 Pieces/Bag
Weight	0.750KG/M



Description	ALL VINYL HEADER PD02-002
Package	4 Pieces/Bag
Weight	2KG/M

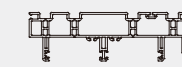

Description	ALL VINYL JAMB PD02-003
Package	4 Pieces/Bag
Weight	1.640KG/M

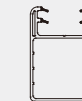

Description	LOCKER RAIL PD01-005
Package	12 Pieces/Bag
Weight	0.580KG/M

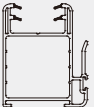

Description	INTERLOCK PD01-004
Package	8 Pieces/Bag
Weight	0.750KG/M

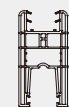

Description	TOP & BOTTOM SASH PD03-006
Package	6 Pieces/Bag
Weight	1.250KG/M



Description	FIXED SUPPORT PD02-007
Package	15 Pieces/Bag
Weight	0.42KG/M

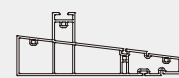

Description	ALL VINYL SILL-1 TOWER PD02-001
Package	4 Pieces/Bag
Weight	1.470KG/M

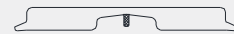

Description	PANEL SCREW COVER PD02-012
Package	40 Pieces/Bag
Weight	0.137KG/M

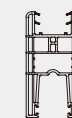

Description	TOP & BOTTOM SASH PD03-006
Package	6 Pieces/Bag
Weight	1.250KG/M

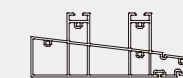

Description	ALL VINYL SILL-2 TOWER PD02-001D
Package	4 Pieces/Bag
Weight	1.840KG/M

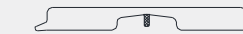

Description	PANEL SCREW COVER PD02-012
Package	40 Pieces/Bag
Weight	0.137KG/M

SG Window System

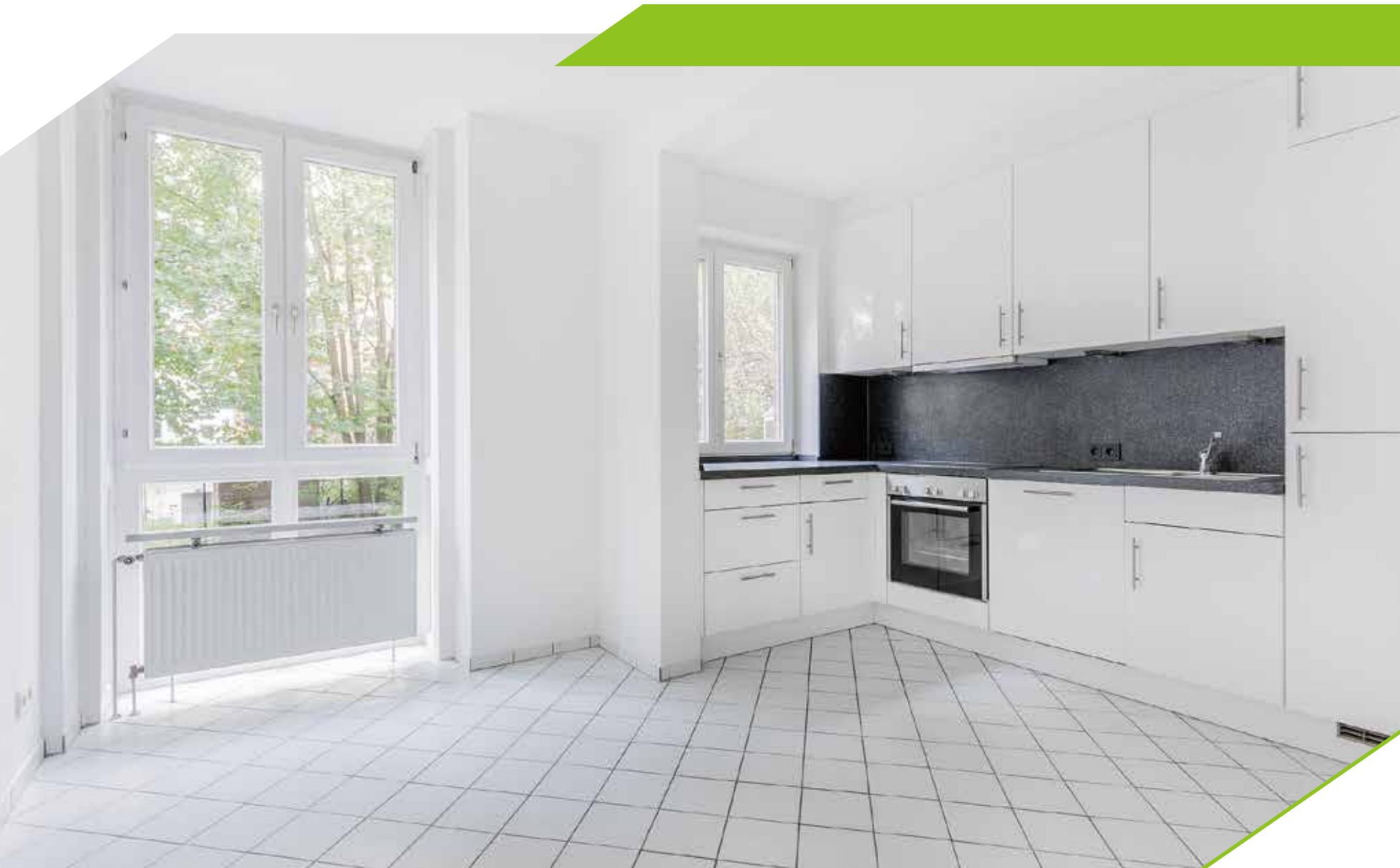

SG005 Series

SG005 Fixed Window

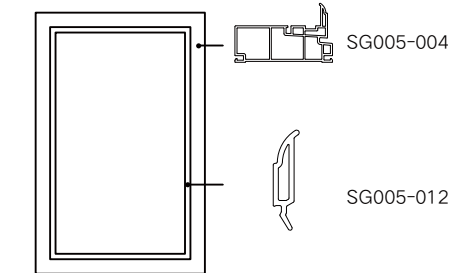

Window Screen
(Optional)

Description	PICTURE FRAME SG005-004
Package	8 Pieces/Bag
Weight	0.936KG/M

Description	7/8" GLAZING STOP SG005-012
Package	40 Pieces/Bag
Weight	0.082KG/M

SG005 Casement Window

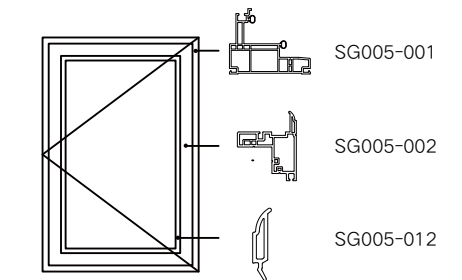

Window Screen
(Optional)

Description	CASEMENT FRAME SG005-001
Package	6 Pieces/Bag
Weight	1.08KG/M

Description	CASEMENT SASH SG005-002
Package	8 Pieces/Bag
Weight	0.82KG/M

Description	7/8" GLAZING STOP SG005-012
Package	40 Pieces/Bag
Weight	0.082KG/M

SG005 Single Hung Sliding Window

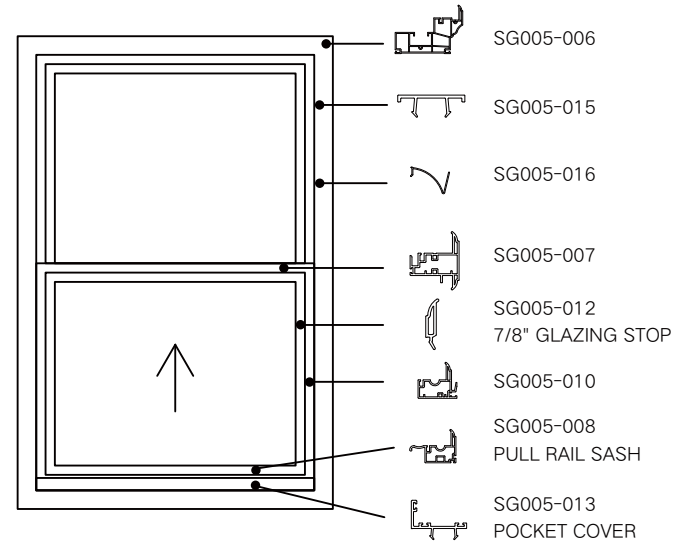

Window Screen
(Optional)



SG005 Double Hung Sliding Window

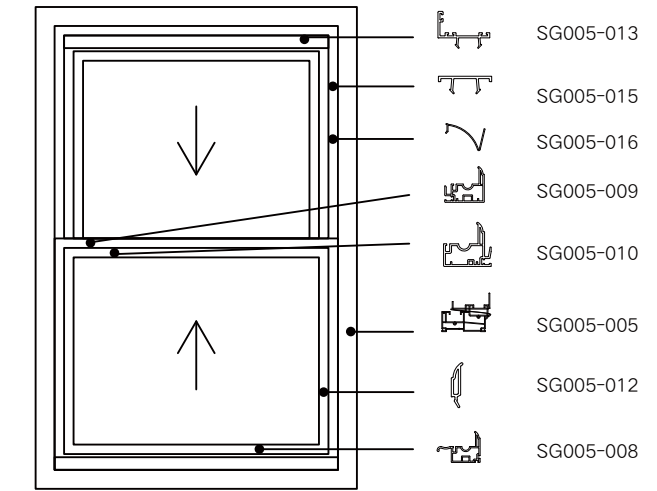

Window Screen
(Optional)

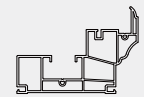

Description	SINGLE HUNG FRAME SG005-006
Package	4 Pieces/Bag
Weight	1.239KG/M

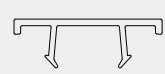

Description	SASH STOP SG005-015
Package	25 Pieces/Bag
Weight	0.147KG/M



Description	BALANCE COVER SG005-016
Package	50 Pieces/Bag
Weight	0.062KG/M

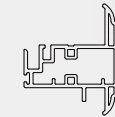

Description	SGL-HUNG MULLION SG005-007
Package	12 Pieces/Bag
Weight	0.545KG/M

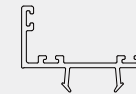

Description	POCKET COVER SG005-013
Package	25 Pieces/Bag
Weight	0.233KG/M

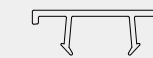

Description	SASH STOP SG005-015
Package	25 Pieces/Bag
Weight	0.147KG/M



Description	BALANCE COVER SG005-016
Package	50 Pieces/Bag
Weight	0.062KG/M

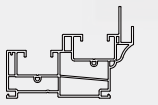

Description	DOUBLE HUNG FRAME SG005-005
Package	4 Pieces/Bag
Weight	1.36KG/M



Description	7/8" GLAZING STOP SG005-012
Package	40 Pieces/Bag
Weight	0.082KG/M

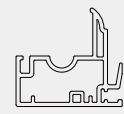

Description	LOCK SASH SG005-010
Package	12 Pieces/Bag
Weight	0.484KG/M

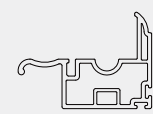

Description	PULL RAIL SASH SG005-008
Package	12 Pieces/Bag
Weight	0.525KG/M

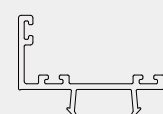

Description	POCKET COVER SG005-013
Package	25 Pieces/Bag
Weight	0.233KG/M



Description	7/8" GLAZING STOP SG005-012
Package	40 Pieces/Bag
Weight	0.082KG/M

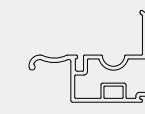

Description	PULL RAIL SASH SG005-008
Package	12 Pieces/Bag
Weight	0.525KG/M

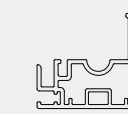

Description	KEEPER RAIL SASH SG005-009
Package	12 Pieces/Bag
Weight	0.462KG/M

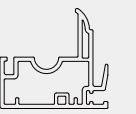

Description	LOCK SASH SG005-010
Package	12 Pieces/Bag
Weight	0.484KG/M



SG Window System

SG010 Series

SG010 Fixed Window

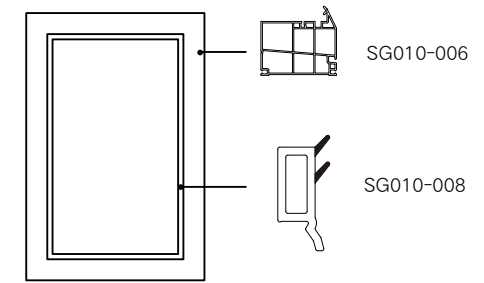

Description	HIGH FIXED FRAME SG010-006
Package	4 Pieces/Bag
Weight	1.300KG/M

Description	GLASS STOP SG010-008
Package	50 Pieces/Bag
Weight	0.118KG/M



Window Screen
(Optional)

SG010 Casement Window

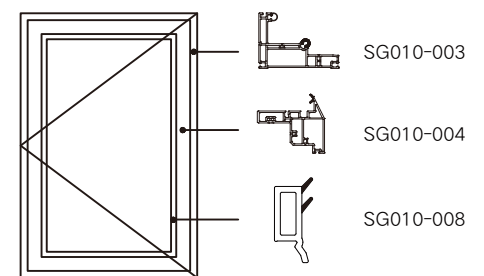

Description	CASEMENT FRAME SG010-003
Package	6 Pieces/Bag
Weight	0.990KG/M

Description	CASEMENT SASH SG010-004
Package	8 Pieces/Bag
Weight	0.820KG/M



Window Screen
(Optional)

Description	MAIN GLASS STOP SG010-008
Package	50 Pieces/Bag
Weight	0.118KG/M

SG010 Single Hung Sliding Window

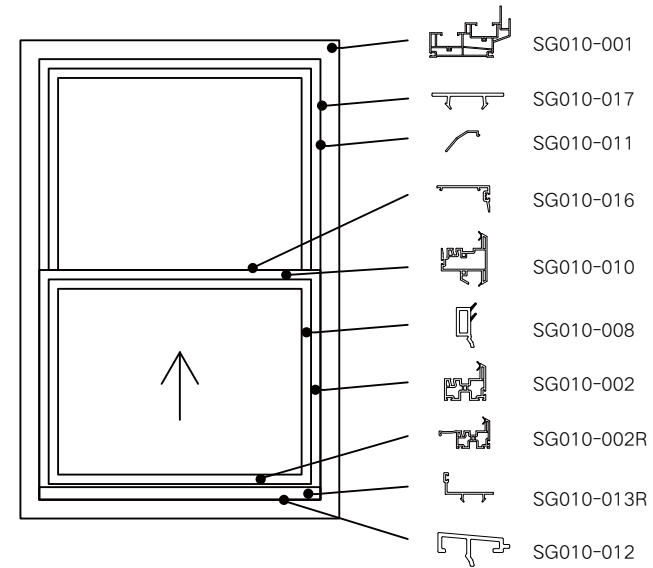

Window Screen (Optional)



SG010 Double Hung Sliding Window

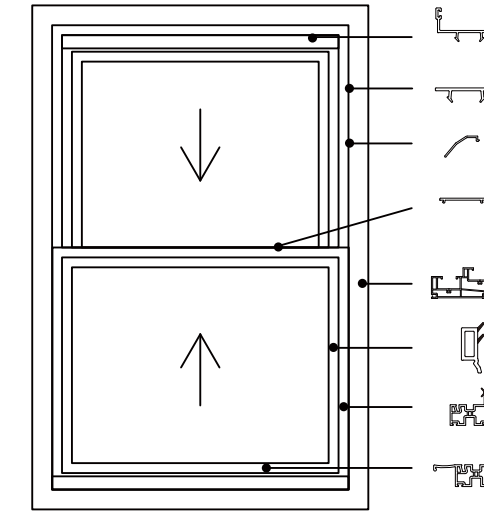

Window Screen (Optional)

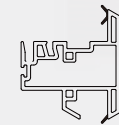
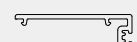
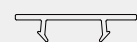
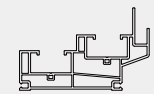

Description	DOUBLE HUNG FRAME SG010-001
Package	4 Pieces/Bag
Weight	1.330KG/M

Description	SASH STOP SG010-017
Package	25 Pieces/Bag
Weight	0.102KG/M

Description	BALANCE COVER SG010-011
Package	50 Pieces/Bag
Weight	0.07KG/M

Description	INTERLOCK SG010-016
Package	25 Pieces/Bag
Weight	0.180KG/M

Description	SINGLE HUNG MULLION SG010-010
Package	6 Pieces/Bag
Weight	0.620KG/M

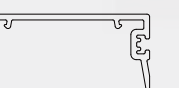
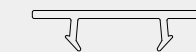
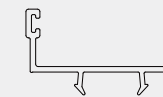

Description	NEW POCKET COVER SG010-013R
Package	30 Pieces/Bag
Weight	0.193KG/M

Description	SASH STOP SG010-017
Package	25 Pieces/Bag
Weight	0.102KG/M

Description	BALANCE COVER SG010-011
Package	50 Pieces/Bag
Weight	0.07KG/M

Description	INTERLOCK SG010-016
Package	25 Pieces/Bag
Weight	0.180KG/M

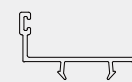
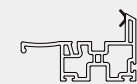
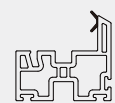

Description	GLASS STOP SG010-008
Package	50 Pieces/Bag
Weight	0.118KG/M

Description	HUNG SASH SG010-002
Package	12 Pieces/Bag
Weight	0.490KG/M

Description	PULL RAIL SASH SG010-002R
Package	12 Pieces/Bag
Weight	0.577KG/M

Description	NEW POCKET COVER SG010-013R
Package	30 Pieces/Bag
Weight	0.193KG/M

Description	SCREEN STOP SG010-012
Package	24 Pieces/Bag
Weight	0.140KG/M

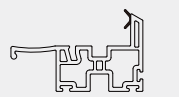
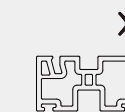
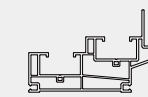

Description	DOUBLE HUNG FRAME SG010-001
Package	4 Pieces/Bag
Weight	1.330KG/M

Description	GLASS STOP SG010-008
Package	50 Pieces/Bag
Weight	0.118KG/M

Description	HUNG SASH SG010-002
Package	12 Pieces/Bag
Weight	0.490KG/M

Description	PULL RAIL SASH SG010-002R
Package	12 Pieces/Bag
Weight	0.577KG/M